

Article number: 433000045

Description: Rota-fix shaft-hub connection C 45x52

Note: Not self centering. Small radial dimensions

Measures

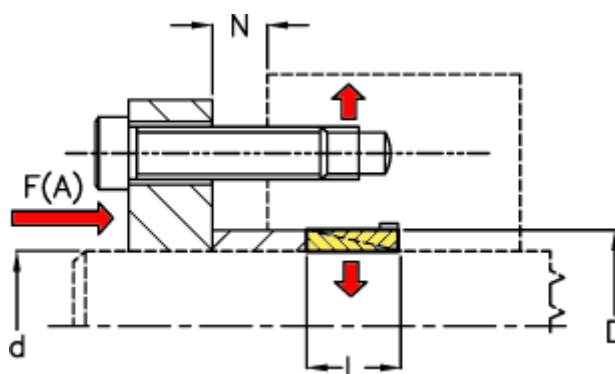

d mm = 45

D mm = 52

F(A) kN = 110

Fit tolerance = Aksel \varnothing ? 38 h6, Aksel \varnothing > 38 h8, Nav \varnothing ? 38 H7, Nav > \varnothing 38 H8

F kN torque = 17.0

L = 10

N1 = 4

N2 = 5

N3

N4

P N/mm² surface press

Surface roughness

T N m torque